

24小时服务热线
24-hour service hotline

4006-05-4007

菱高快速电梯有限公司

LINGGAO EXPRESS ELEVATOR CO., LTD.

地址: 江苏省苏州市吴江区震泽镇大船港开发区

Add: Big Ship Harbor Development Zone, Zhenze Town, Wujiang District, Suzhou City, Jiangsu Province, China

电话(Tel): 0512-63785176 0512-63785276

传真(Fax): 0512-63785876 邮编(P.C): 215231

E-mail: lg@lgelevator.com

网址(Web): www.lgelevator.com

本书为一般信息类出版物, 我们保留随时更改产品设计和说明的权利。

本书的任何字句, 无论其字面意思或含义, 对于任何产品及该产品的用途和质量, 或者任何购销合同条款的表述与更改均不承担任何责任。

2020年1月份印刷



扫一扫, 即可了解产品详情
Scan here to learn more about the product
LINGGAO express elevator



LG Express Lift

LINGGAO EXPRESS ELEVATOR

別墅电梯系列

Villa elevator series



STM 瑞斯传媒 0573-88133500 18868047066

Intelligent security

智能安全

It never traps any passengers

永不关人

ARD系统我们也称之为别墅梯永不关人系统，具有故障自行诊断，电流、电压识别功能。当停电或开关老化、变频器损坏时，ARD系统可直接无缝切换驱动曳引机，绕开繁琐的控制系统及变频器，将乘坐人员、老人或儿童安全快速的输送到指定楼层，确保别墅电梯永不关人。

ARD system never traps any passengers in villa elevators. It automatically diagnoses any trouble and recognize current / voltage. If power fails or switch is aged / frequency changer is damaged, ARD system can directly fulfill seamless change-over to drive tractor. It eliminates any kind of complex control system and frequency changer. It safely and quickly delivers the passengers / the old / kids to the designated floor. It thus ensures that villa elevator never traps any passengers.



One-key dialing

一键拨号

当电梯因故障无法运行时，当乘客受困于电梯内，长按Artist calling的按钮4秒后，Artist calling会立即拨出给设置的五组号码。第一组电话未接通会自动转接第二组.....以此类推。以便及时找到有家中钥匙的人前往解救，给予老人与小孩最大的关怀与保护。

If elevator is damaged and passengers are trapped in the elevator, after continuously pressing "Artist calling" press-button for 4 second, Artist calling will then give the set 5-group numbers. If first group of call is not connected, it automatically goes to second one and so on. It is convenient for the trapped passenger to promptly find the family with home key for rescue. It cares and protects the old and kids to maximum extent.

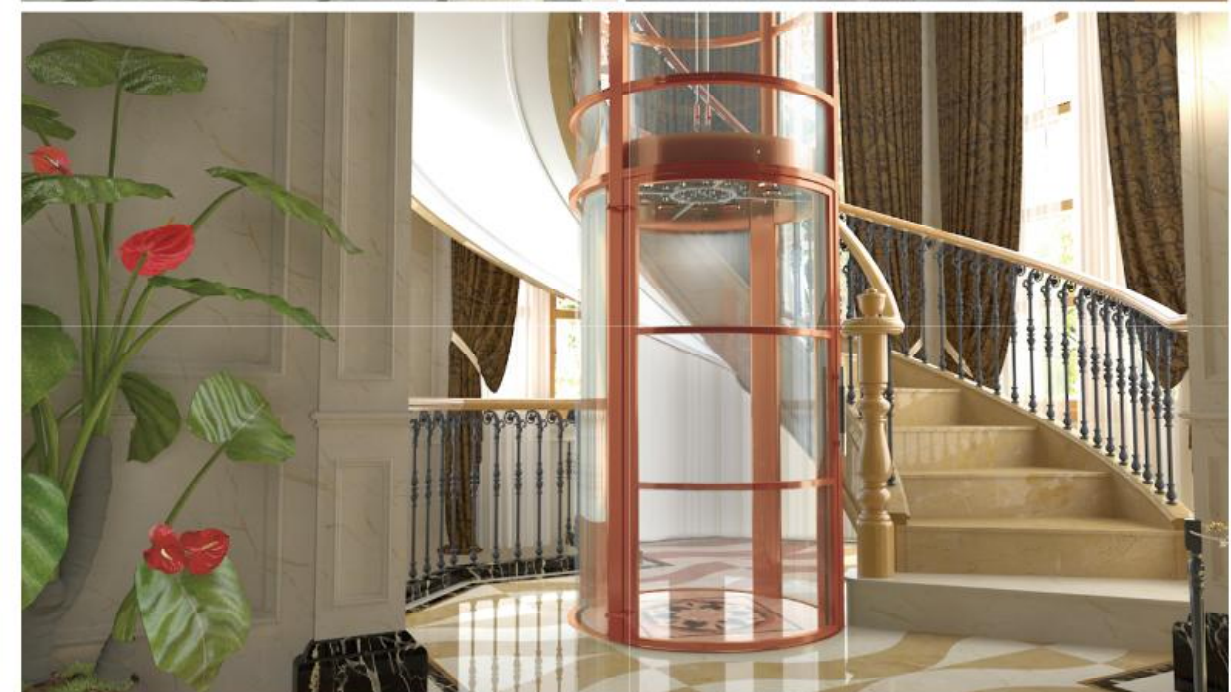

Emergency calling system

强驱式结构

菱高电梯采用先进的电梯强制式驱动和数字化控制变频调速技术，运行平稳。无需对重，无齿轮箱，体积小，安装简便，完全可以实现无机房，相比较传统液压梯，节省成本，更节约空间。

Linggao forcible drive villa elevator applies the advanced elevator forcible-drive and digital control variable frequency and speed regulation technology with smooth operation. It needs no counterweight, no gear-box with small bulk, simple and convenient installation. It completely fulfills machine room-less. Compared with traditional hydraulic elevator, it saves more cost and space.

Positive Drive Machine 强驱式驱动主机

采用减速主机加双绳轮结构。125%超载荷制停、双制动块冗余设计。结构紧凑、布置灵活。

Adopt reduction machine and double sheaves structure; stop running when with 125% overload and with double brake design. All of this makes compact structure and flexible arrangements.

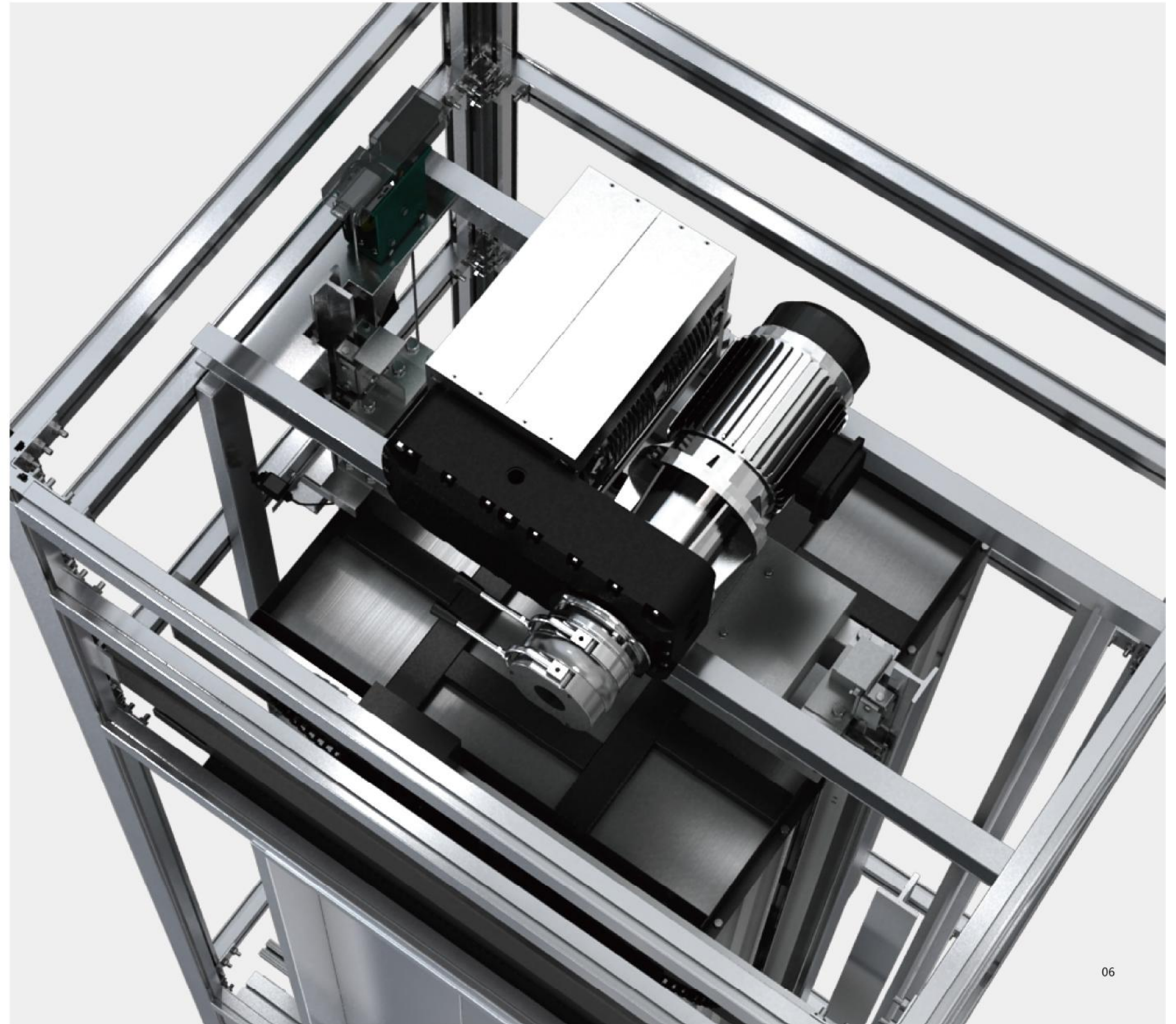

Well solution plan

井道解决方案

Steel frame type well
钢架型井道

High grade painted metal frame
高级喷涂金属框架



Side panel
侧板

玻璃侧板 Glass side panel



高级喷涂钢板 Advanced spray panel



木纹侧板 Wood grain side panel



Aluminum alloy well frame
铝合金井架

High grade painted metal frame
高级喷涂金属框架



Column
立柱

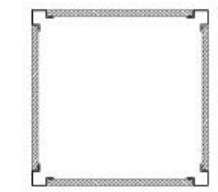

钢架型型材 (板材折弯型)
Steel profile (Bent sheets)

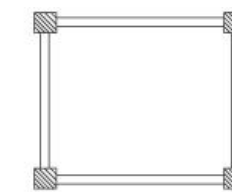

铝合金型材 (矩形管立柱)
Aluminum alloy section material
(Rectangle tube vertical shaft)

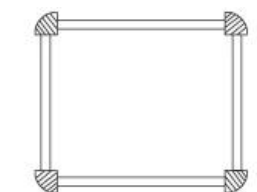

铝合金型材 (半圆弧形管立柱)
Aluminum alloy section material
(half-round arc tube vertical shaft)

Villa elevator car decoration

别墅电梯轿厢装潢



LG20-V01 选配 /Optional



吊 顶：发纹不锈钢，LED照明
轿 壁：发纹不锈钢，镜面不锈钢
扶 手：不锈钢扁扶手
地 板：PVC

Ceiling: Hairline stainless steel, LED lighting
Car wall: Hairline stainless steel, mirror stainless steel
Handrail: Stainless steel flat armrest
Floor: PVC



LG20-V02 选配 /Optional



吊 顶：镜面不锈钢，亚克力灯饰，LED照明
轿 壁：钛金不锈钢，钛金镜面蚀刻不锈钢
扶 手：无
地 板：PVC

Ceiling: Mirror stainless steel, acrylic light decoration, LED lighting
Car wall: Titanium stainless steel, titanium mirror etching stainless steel
Handrail: None
Floor: PVC



LG20-V03 选配 /Optional



吊 顶：镜面不锈钢，LED照明
轿 壁：木纹饰面，安全夹胶玻璃
扶 手：无
地 板：PVC

Ceiling: Mirror stainless steel, LED lighting
Car wall: Veneer, safety laminated glass
Handrail: None
Floor: PVC



LG20-V04 选配 /Optional



吊 顶：发纹不锈钢，亚克力灯饰
轿 壁：镜面不锈钢，蚀刻，发纹不锈钢
扶 手：无
地 板：PVC

Ceiling: Hairline stainless steel, acrylic lamp
Car wall: Mirror stainless steel, etching, hairline stainless steel
Handrail: None
Floor: PVC

Villa elevator car decoration

别墅电梯轿厢装潢

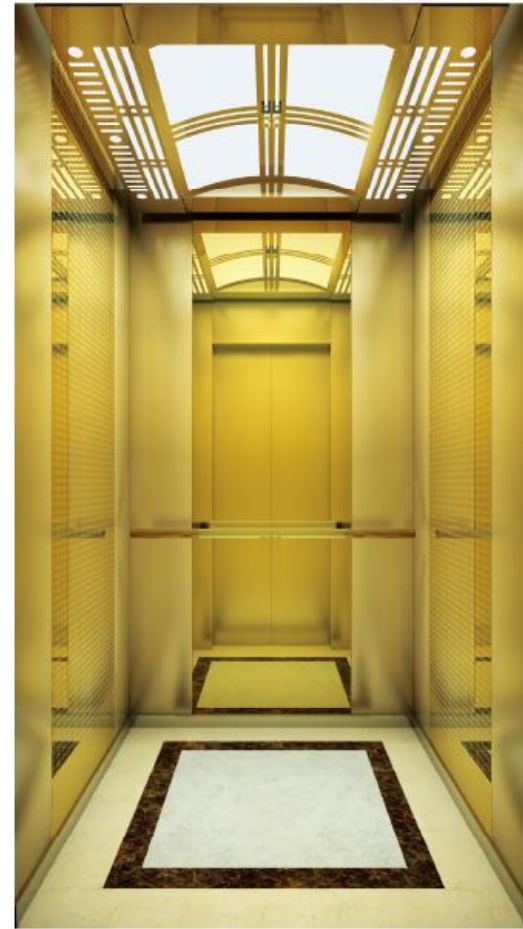

LG20-V05 选配 /Optional



吊顶：钛金镜面不锈钢，亚克力灯饰
轿壁：钛金发纹不锈钢，钛金镜面蚀刻不锈钢
扶手：钛金不锈钢与圆木组合扶手
地板：PVC

Ceiling: Titanium gold mirror stainless steel, acrylic light decoration
Car wall: Titanium gold hairline stainless steel, titanium gold hairline stainless steel
Handrail: Titanium gold hairline stainless steel
Floor: PVC



LG20-V06 选配 /Optional



吊顶：镜面不锈钢，亚克力灯饰，LED灯
轿壁：玫瑰金镜面蚀刻，玫瑰金镜面不锈钢，发纹不锈钢
扶手：不锈钢扁扶手
地板：PVC

Ceiling: Mirror stainless steel, acrylic light decoration, LED lighting
Car wall: Rose gold mirror etched, rose gold mirror stainless steel, hairline stainless steel
Handrail: Stainless steel flat handrail
Floor: PVC



LG20-V07 选配 /Optional



吊 顶：烤漆木板（象牙白）
轿 壁：烤漆木板（象牙白），镜面不锈钢
扶 手：无
地 板：PVC

Ceiling: Baked enamel wood panel (ivory white)
Car wall: Baked enamel wood panel (ivory white), mirror stainless steel
Handrail: None
Floor: PVC

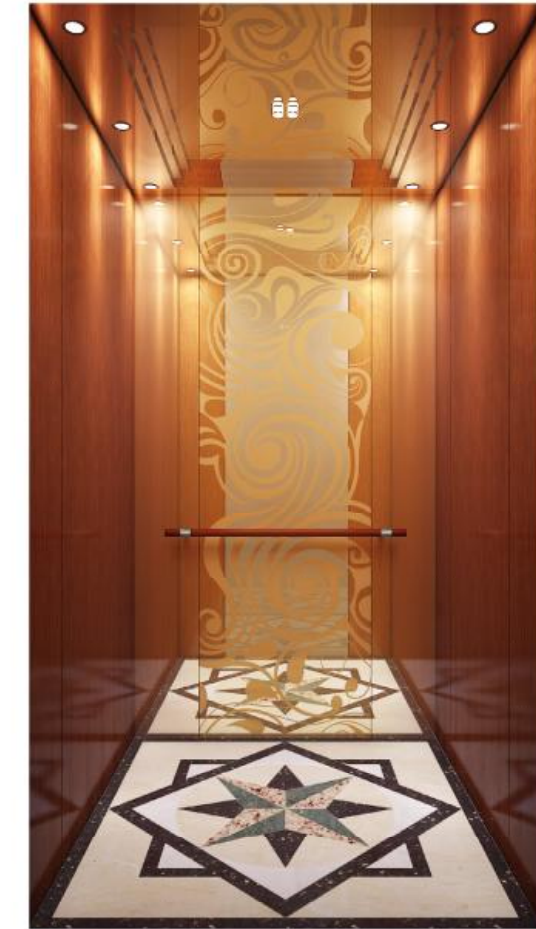

LG20-V08 选配 /Optional



吊 顶：钛金镜面不锈钢，亚克力灯饰，LED灯
轿 壁：木纹装饰板，钛金镜面蚀刻不锈钢
扶 手：圆木不锈钢扶手
地 板：PVC

Ceiling: Titanium gold mirror stainless steel, acrylic light decoration, LED lighting
Car wall: Wood grain decoration panel, titanium gold mirror etched stainless steel
Handrail: Round wood stainless steel handrail
Floor: PVC

Human-machine interface

人机界面



图片机
Graphics machine

None bottom box hall button (Optional)
无底盒外呼 (选配)

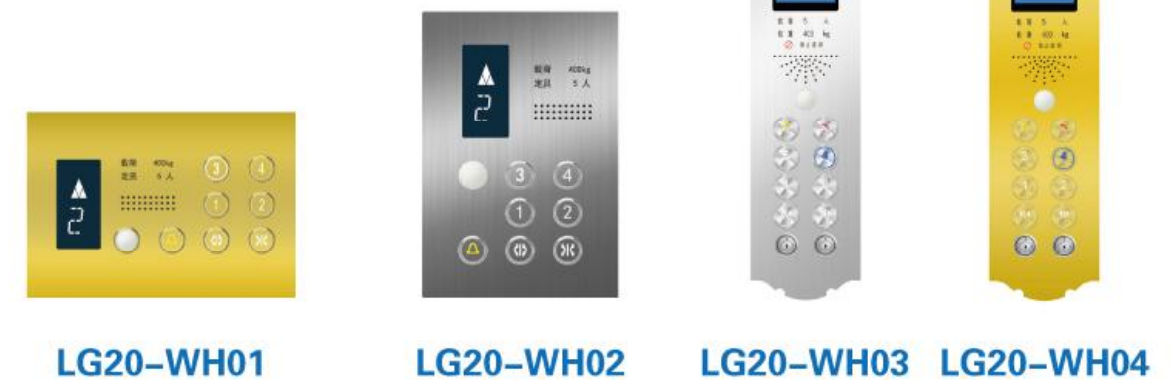

Light colors of buttons
按钮发光颜色



由于印刷工艺的限制，实际加工的颜色可能与目录略有不同，最终选型可根据实际材料和色样决定。
Because of restrictions in aspect of printing craft and technology, there will be slight difference between colors in this catalogue, the final model selection can be decided according to the actual material and color specimen.

Landing door design

厅门设计



LG20-VM01 选配 Optional
发纹不锈钢
Hairline stainless steel



LG20-VM02 选配 Optional
有框玻璃门
Framed glass door



LG20-VM03 选配 Optional
镜面蚀刻不锈钢
Mirror etching stainless steel



LG20-VM04 选配 Optional
钛金蚀刻不锈钢
Titanium gold etched stainless steel



LG20-VM05 选配 Optional
木饰面
Wood veneer



LG20-VM06 选配 Optional
玫瑰金蚀刻不锈钢
Rose gold etched stainless steel

Ceiling design

吊顶设计

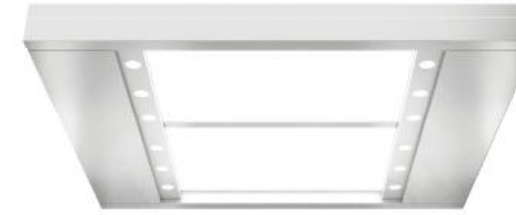

LG20-VD01 选配 Optional
发纹不锈钢, 亚克力灯饰
Hairline stainless steel, acrylic lighting
decoration



LG20-VD02 选配 Optional
发纹不锈钢, 亚克力灯饰
Hairline stainless steel, acrylic lighting
decoration



LG20-VD03 选配 Optional
发纹不锈钢, 亚克力灯饰
Hairline stainless steel, acrylic lighting
decoration



LG20-VD04 选配 Optional
发纹不锈钢, 亚克力灯饰, LED灯
Hairline stainless steel, acrylic lighting
decoration, LED lighting

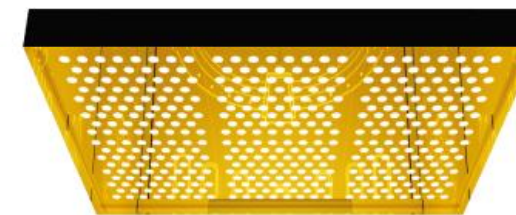

LG20-VD05 选配 Optional
钛金镜面不锈钢, 亚克力灯饰
Titanium gold mirror stainless steel, acrylic
lighting decoration



LG20-VD06 选配 Optional
钛金镜面不锈钢, 亚克力灯饰
Titanium gold mirror stainless steel, acrylic
lighting decoration

Handrail design

扶手设计



LG20-FS01
选配 Optional



LG20-FS02
选配 Optional



LG20-FS03
选配 Optional



LG20-FS04
选配 Optional



LG20-FS05
选配 Optional

Floor design

地板设计



LG20-DB01
选配 Optional



LG20-DB02
选配 Optional



LG20-DB03
选配 Optional



LG20-DB04
选配 Optional

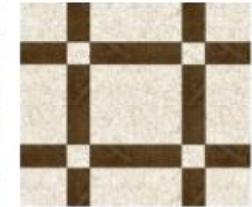

LG20-DB05
选配 Optional

门拉手 Door handle



LG20-VH01
选配 Optional



LG20-VH02
选配 Optional



LG20-VH03
选配 Optional



LG20-VH04
选配 Optional



LG20-VH05
选配 Optional



LG20-VH06
选配 Optional

色卡 Color card



冰灰
Ice gray



飞机灰
Plane gray

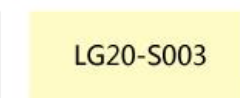

米黄
Corny yellow



群青蓝
Ultramarine blue



浅绿色
Light green

● 图片系电脑绘制，可能与实际略有不同。
The pictures are plotted by computer and are likely somewhat different from the actual products.

All-round services

全方位服务



Before sale service

售前服务

电梯配置方案 Elevator configuration plans

菱高快速电梯的工程师们根据建筑的使用、美学特点，结合人流量、使用习惯、内外交通环境等参数，为客户在成本与性能方面寻求最佳平衡，选取最适合客户的电梯产品。

Linggao Express Elevator engineers seek the best balance in the aspects of cost and performance for vast clients according to building use, aesthetics characteristics in combination with passenger flow, operational habits, inner / outer traffic environment parameters etc. They help the clients to choose the most proper elevators.

土建工程方案 Construction project plans

菱高快速电梯的土建工程顾问将有预见性和准确研究并道基建环境，适时参与建筑规划与建造过程，确保以最小的施工量和面积满足电梯配置，为开发商赢得更多增值空间。

Construction project advisors of Linggao Express Elevator will predictably and accurately research into well infrastructure environments. They properly participate into construction planning and process. It ensures to satisfy the elevator configuration by minimum construction volume and area. It wins more and more value-adding spaces for vast developers.



Mid sale service

售中服务

安装调试 Installation & adjustment

电梯系统进入安装调试阶段，通常楼宇也开始交付使用，因此每个细节和进程的集约控制程度将对发展商、物业管理商和业主的利益产生直接的影响。菱高快速电梯的电梯安装工程监理人员拥有多年专业经验，会在最适合的时间进场安排，并能轻松驾驭各种复杂多变的安装环境。

When elevator system enters into installation and adjustment stages, usually the buildings will be delivered for use. Therefore intensive control progress for every detail and process directly influences the benefits of developer, housing property management and owners. Elevator installation project supervisors of Linggao Express Elevator own the years' professional experiences. They will arrange the most proper time for elevator shows. It can easily grasp various complex and changeable installation environments.

现场安装 Site installation

电梯的“总装配”在现场，现场安装是电梯装配的最重要的环节。菱高快速电梯委派专职的项目经理负责安装工程的计划、协调、人力调配及工程质量、安全管理等工作。每一个工程项目实施前，项目经理都要召开专题会议，严格制定施工方案及详细进行技术交底，并根据工地现场实际情况制定应急方案，确保按时、按质完成。

Elevator General Assembly at Site: Site installation is a key sector of elevator assembly. Linggao Express Elevator assigns special project manager to be responsible for installation project planning, coordination, labor dispatch, project quality supervision, safety management etc. before executing every project, Project Manager always convenes "Topic Meeting". It strictly formulates construction plans and detailed technical submission. It carries out emergency plans according to actual conditions at construction site. It guarantees prompt and high quality completion.



After sale services

售后服务

维保及更新服务 Maintenance and renewal

菱高快速电梯承诺：遇紧急维修，技术人员将在50分钟以内抵达全球任何一部投入使用的菱高快速电梯。

Pledge of Linggao Express Elevator: Upon emergency repair, technicians will arrive at any Linggao express elevator that is thrown into use all over the world within 50 minutes.

专业团队免费维护一年，分半个月、一个月、一个季度定期保养维修，每年年检，减少故障。

One year free maintenance from our professional teams: It is divided into half a month, monthly, seasonal regular repair and maintenance. Annual inspections reduce the trouble rates.

远程监控服务系统，是菱高快速电梯售后服务的重要组成部分。实施远程监控最大的优点就是能够在电梯运行尚处于“正常”时诊断出问题，使客户还未察觉到问题前就解决问题。

Long-Distance Monitor Service System is an important constituent of Linggao Express Elevator After Sale Service. Its maximum advantage is to diagnosis any problem while elevator is still in "normal" operation. It thus solves the problems before the clients are aware of the problems.

个性化服务 Individual services

菱高快速电梯的客服中心将呼叫中心、SMS客户管理系统、多媒体移动监控系统、技术帮助系统整合优化，成为与客户沟通的重要纽带，确保客户一年365天都能享受到值得信赖的服务。

Linggao Express Elevator Customer Service Center optimizes and integrates with Calling Hotline, SMS Customer Management System, Multi-Media Mobile Monitor System, Technical Help System. It becomes a significant tie with customer communication. It ensures that the clients enjoy our trustworthy services 365-day a year.

原厂配件库覆盖全国，供给充足，24小时支援客户召修要求，保证了最快的响应时间和最短的维修时间。

Original Parts Warehouses are wide-spreading all over the country with ample supply. It executes 24-hour support to the customers' "calling for repair". It ensures the quickest response time and the shortest repair period.

菱高快速电梯一贯重视保养技术的研发，针对不同梯种特性、使用环境，配合使用维修专用计算机、特殊工具和工装，制定独有的保养工艺流程。除了日常的保养工作外，针对客户的电梯实际运行状况，制定出个性化的保养方案，真正做到“预防为主，防范于未然”。

Linggao Express Elevator always thinks highly of researching into and developing maintenance technology. Aiming at different elevator characteristics and operational environments, it matches with maintenance special-purpose computer, special tools and tooling to formulate the particular maintenance craft and technological flow. Apart from daily maintenance, targeting upon the clients' actual elevator operation conditions, it works out individual maintenance plans. It truly fulfills the purpose of "mainly preventative measures to remove any hidden dangers".